

Product information

20 02 160

- Flat, short, wide jaws
- Suitable for gripping flat materials in easily accessible places
- Knurled gripping surfaces

Flat Nose Pliers

DIN ISO 5745



General	
Article No.	20 02 160
EAN	4003773035008
Pliers	black atramentized
Head	polished
Handles	with multi-component grips
Weight	172 g
Dimensions	160 x 53 x 19 mm
Standard	DIN ISO 5745
REACH compliant	does not contain SVHC
RoHS compliant	not applicable

Technical details	
Jaw thickness (joint) (T1)	9.5 mm
Jaw length (L3)	30.0 mm
Head width (W3)	17.0 mm

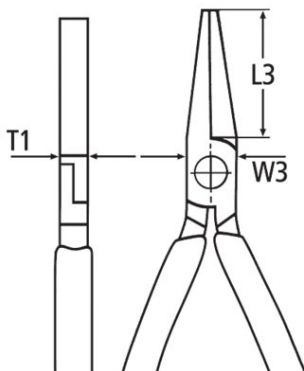

technical change and errors excepted

